

IP67防水数显可换测头卡尺 870

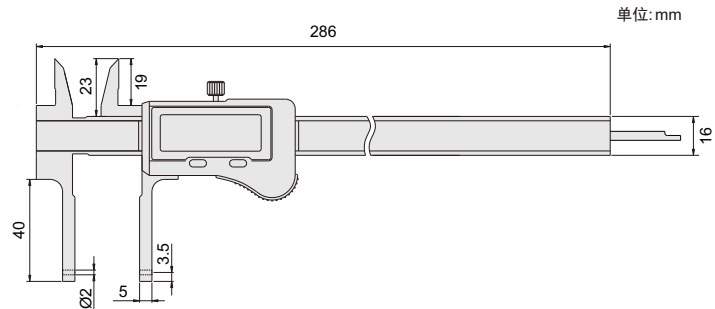

- ◆ 符合JB/T异形卡尺国家机械行业标准
- ◆ 配四对可换测头
- ◆ 配外测对零块(10mm)
- ◆ IP67 防护等级
- ◆ 绝对测量系统
- ◆ 分辨率:0.01mm/0.0005"
- ◆ 自动关机
- ◆ 按键功能:置零,公英制转换,预置初始值
- ◆ 不锈钢尺身

对零块(标配)

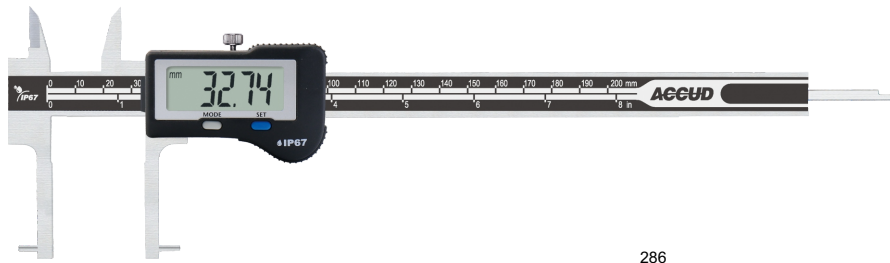
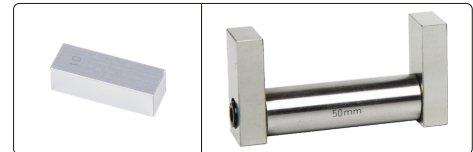

圆柱球面测头(标配)

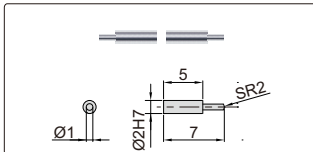

球面/平面短测头(标配)

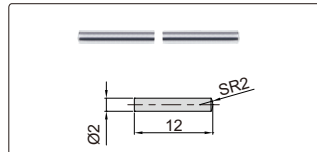

球面薄片短测头(标配)

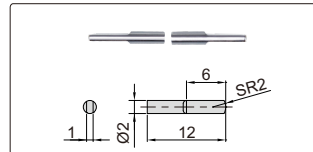

球面/平面长测头(标配)

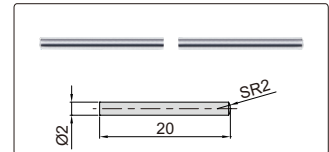

测头安装方式

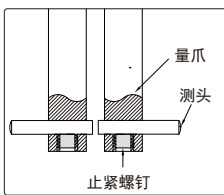

测量内凹槽和外凹槽

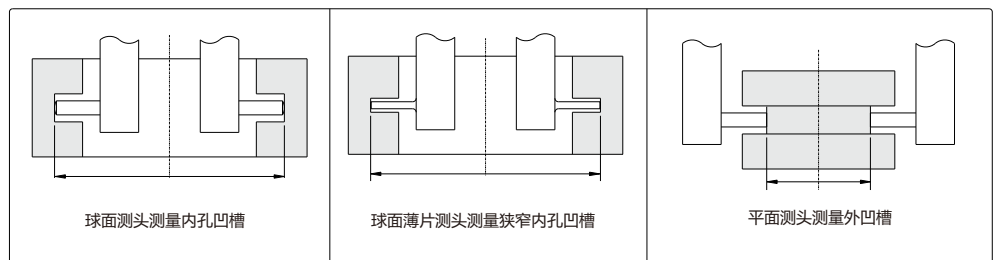

货号	测头	测量范围	精度	适用范围
870-008-11	圆柱球面测头	14-214mm/0.6-8.6"(内尺寸) 0-196mm/0-7.7"(外尺寸)	±0.04mm	球面测头测量内孔凹槽(小孔)
	球面/平面短测头	24-224mm/1-8.8"(内尺寸) 0-186mm/0-7.3"(外尺寸)	±0.04mm	球面测头测量内孔凹槽(小孔) 平面测头测量外凹槽
	球面/平面长测头	40-240mm/1.6-9.6"(内尺寸) 0-170mm/0-6.7"(外尺寸)	±0.04mm	球面测头测量内孔凹槽(大孔) 平面测头测量外凹槽
	球面薄片短测头	24-224mm/1-8.8"(内尺寸) 0-186mm/0-7.3"(外尺寸)	±0.04mm	测量狭窄内孔凹槽(小孔)